



# KATALOG / CATALOG

PRODUCENT KLATEK DLA PTAKÓW I MAŁYCH ZWIERZĄT  
MANUFACTURER OF BIRD AND SMALL ANIMAL CAGES

WD-IMPEX oferuje wysokiej jakości klatki dla ptaków i gryzoni w szerokiej gamie rozmiarów i kolorów. Założycielem firmy był Witold Mikołajewski, który w 1956 roku otworzył pierwszy sklep zoologiczny w Częstochowie. Jego zamiarem było stworzenie wysokiej klasy placówki zarówno pod względem fachowego doradztwa, jak i szerokiego asortymentu. Z czasem, wspierany w swoich działaniach przez żonę Barbarę, postanowił rozszerzyć działalność o produkcję klatek dla zwierząt. W 1978 roku w przydomowym warsztacie została założona firma produkcyjna. Poparta praktyką wiedza z zakresu zoologii umożliwiła rozwinięcie profesjonalnego wytwórstwa. Dzięki dobrej jakości oraz bogatemu asortymentowi firma i jej produkty szybko zyskały uznanie na rynku krajowym i za granicą. W 1990 roku rodzinna firma przyjęła nazwę WD-IMPEX i znacznie rozszerzyła swoją działalność. Obecnie prowadzą ją dzieci założycieli: Dariusz Mikołajewski i Dorota Jakubow. Dzisiaj WD-IMPEX to prężnie działające przedsiębiorstwo, które stale się rozwija i unowocześnia, rozszerzając asortyment. Przywiązuje szczególną uwagę do jakości produktów i zadowolenia klientów. Swoją ofertę prezentuje na międzynarodowych targach. Klatki dla ptaków i małych zwierząt produkowane przez WD-IMPEX cieszą się bardzo dobrą opinią. Można je znaleźć w sklepach w całej Polsce i za granicą.

Zapraszamy do zapoznania się z naszą ofertą.

---

WD-IMPEX offers high quality cages for birds and small animals in a wide range of sizes and colours. The company was founded by Witold Mikołajewski, who opened in 1956 the first pet shop in Częstochowa. His intention was to set up a high-class establishment in terms of both professional advice and a wide product range. Over time with the support of his wife Barbara, he decided to broaden his activities to include the production of animal cages. In 1978 he started a production business in a workshop next to his home. His knowledge in the area of zoology, backed up by experience, enabled the development of professional manufacturing. Owing to good quality and a wide range, the firm and its products soon gained recognition on the national market and foreign markets. In 1990 the family firm adopted the name WD-IMPEX and considerably widened its activities. It is now run by the founder's children: Dariusz Mikołajewski and Dorota Jakubow. Today, WD-IMPEX is a dynamically expanding company that continues to constantly develop, upgrade and broaden its product range. It pays particular attention to product quality and customer satisfaction. In addition, it exhibits at international trade fairs and is thus well-known on a multitude of markets. Cages for birds and small animals manufactured by WD-IMPEX enjoy a very good reputation. They are available in shops all over Poland and abroad.

We warmly invite you to view our products on offer and enter cooperation with our professional staff.



[www.wd-impex.com.pl](http://www.wd-impex.com.pl)

## KOLORYSTYKA / COLOR



kolor drutu / colour of wire



biały / white



czarny / black



niebieski / blue



kolor ocynku / painted zinc



ciemna zieleń / dark green



bordowy / burgundy



ocynk / zinc

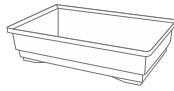

kolor spodu / colour of bottom



żółty / yellow



czerwony / red



niebieski / blue



jasny niebieski / light blue



ciemny granat / navy blue



zielony jasny / light green



ciemna zieleń / dark green



beżowy / cappuccino



brązowy / brown



bordowy / burgundy



malinowy / dark pink



szary / grey



fioletowy / violet



jasny różowy / light pink



seledynowy / aquamarine

## LEGENDA / LEGEND



klatka składana / flat packed cage



ilość klatek w opakowaniu + cbm opakowania /  
items quantity in the box + cbm of packaging



waga / weight



wymiary zewnętrzne / external dimensions



wymiary wewnętrzne / internal dimensions

# KLATKI DLA MAŁYCH ZWIERZĄT

## CAGES FOR SMALL ANIMALS

- 8  CHOMIK / HAMSTER
- 27  MYSZ / MOUSE
- 28  SZCZUR / RAT
- 29  FRETKA / FERRET
- 30  SZYNSZYLA / CHINCHILLA
- 31  ŚWINKA MORSKA / GUINEA PIG
- 31  KRÓLIK / RABBIT
- 38  AKCESORIA DLA MAŁYCH ZWIERZĄT /  
ACCESSORIES FOR SMALL ANIMALS

# KLATKI DLA PTAKÓW

## CAGES FOR BIRDS

- 42  PTAKI / BIRDS
- 67  AKCESORIA DLA PTAKÓW /  
ACCESSORIES FOR BIRDS



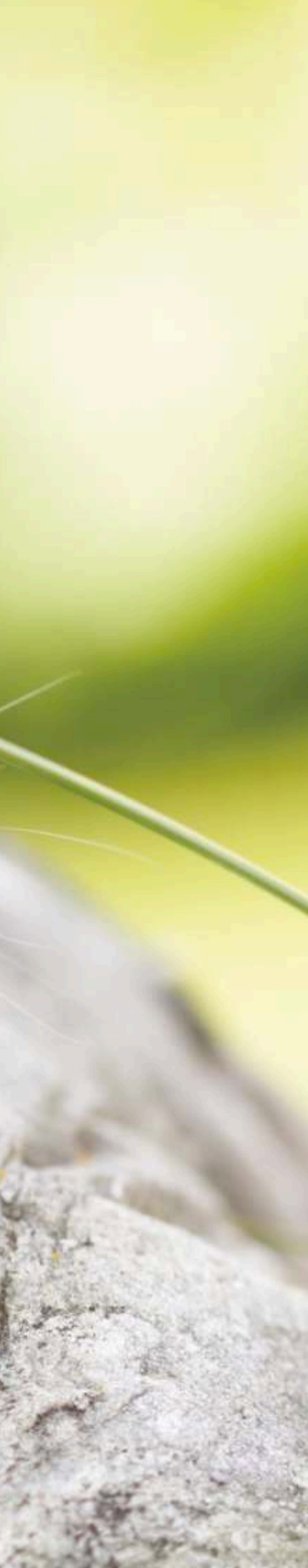

# KLATKI DLA MAŁYCH ZWIERZĄT

CAGES FOR SMALL ANIMALS



# MAT MINI



x1

MAT MINI



5 906775 663585

STRETCH



0,014 m<sup>3</sup>



335 x 200 x 200 mm



0,75 kg



325 x 190 x 200 mm

# CH M



x1



x1



x1



x1

CH M



5 906775 661062



0,05 m<sup>3</sup>



335 x 200 x 385 mm



1,35 kg



325 x 190 x 385 mm







# MAT 1



x1

MAT1



STRETCH



0,02 m<sup>3</sup>



400 x 255 x 220 mm



1,00 kg



390 x 245 x 220 mm

# MAT 1 PLUS



x1

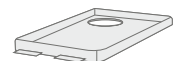

x1



x1

MAT 1 PLUS



STRETCH



0,02 m<sup>3</sup>



400 x 255 x 220 mm



1,16 kg



390 x 245 x 220 mm





# CHS1



x1



x1



x1



x1

CHS1



5 906775 660324



0,07 m<sup>3</sup>



400 x 255 x 265 mm



1,45 kg



390 x 240 x 265 mm

# CHS2



x1



x1



x2



x1



CHS2



5 906775 660331



0,035 m<sup>3</sup>



495 x 325 x 380 mm



1,85 kg



390 x 240 x 340 mm



# CHS3



x1

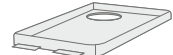

x1



x2



x1

CHS3



0,06 m<sup>3</sup>



400 x 255 x 345 mm



1,70 kg



390 x 240 x 345 mm





# CHS4



x1



x1



x2



x1

CHS4



5 906775 661673



0,035 m<sup>3</sup>



400 x 255 x 390 mm



1,70 kg



390 x 240 x 390 mm

# GUCIO



x1



x2



x3



x1

CHS6



5 906775 663547



0,06 m<sup>3</sup>



400 x 255 x 540 mm



2,04 kg



390 x 245 x 500 mm



# CHATKA



CHATKA



x1



x1



x1



x1



0,07 m<sup>3</sup>



465 x 330 x 440 mm



1,88 kg



390 x 240 x 340 mm

# STANDARD S



x1



x1



x2



x1



0,06 m<sup>3</sup>



400 x 255 x 340 mm



1,60 kg



390 x 240 x 340 mm

STANDARD S





# LUNAPARK 1



x1

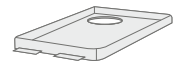

x1



x8



x1

LUNAPARK 1



0,035 m<sup>3</sup>



540 x 255 x 470 mm



2,06 kg



390 x 245 x 330 mm

# LUNAPARK 2



x1

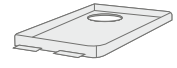

x2



x8



x1

LUNAPARK 2



0,035 m<sup>3</sup>



490 x 325 x 440 mm



2,47 kg



480 x 315 x 290 mm





# OSKAR1



x1

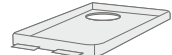

x2



x6



x1

OSKAR1



5 906775 663554



0,035 m<sup>3</sup>



490 x 325 x 490 mm



2,6 kg



480 x 315 x 290 mm

# OSKAR2



x1



x3



x8



x1

OSKAR2



5 906775 663561



0,07 m<sup>3</sup>



490 x 325 x 620 mm



2,99 kg



480 x 315 x 410 mm





# MAT2



x1



x1

MAT2



STRETCH



0,035 m<sup>3</sup>



490 x 325 x 290 mm



1,6 kg



480 x 315 x 290 mm

# MAT 2 PLUS

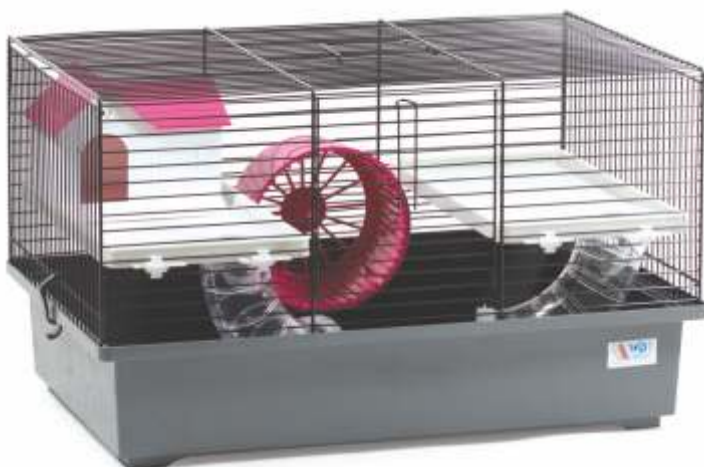

x1



x2



x2



x1

MAT 2 PLUS



0,035 m<sup>3</sup>



490 x 325 x 290 mm



1,95 kg



480 x 315 x 290 mm







# CH1



x1

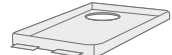

x2



x2



x1

CH1



0,035 m<sup>3</sup>



490 x 325 x 290 mm



2,02 kg



480 x 315 x 290 mm

# CH2



x1



x4



x6



x1



CH2



0,07 m<sup>3</sup>



550 x 380 x 620 mm



3,80 kg



480 x 315 x 580 mm





# CH2 B



CH2 B



5 906775 663059



x1



x2



x4



x1

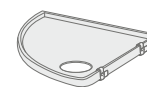

x1



0,07 m<sup>3</sup>



540 x 380 x 620 mm



3,67 kg



480 x 315 x 600 mm

# CH2 PLUS



CH2 PLUS



5 906775 663707



x1



x4



x14



x1



0,07 m<sup>3</sup>



740 x 380 x 760 mm



4,30 kg



480 x 315 x 580 mm





# CH3



CH3



x1

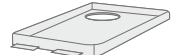

x3



x5



x1



0,07 m<sup>3</sup>



580 x 405 x 680 mm



3,46 kg



480 x 315 x 600 mm

# CH3 PLUS



CH3 PLUS



x1



x4



x14



x1



0,07 m<sup>3</sup>



740 x 400 x 760 mm



4,00 kg



489 x 315 x 600 mm





# CH4



x1



x2



x3



x1



CH4



5 906775 661512



0,05 m<sup>3</sup>



585 x 385 x 550 mm



2,90 kg



480 x 315 x 500 mm

# CH5



x1



x3



x5



x1

CH5



5 906775 660195



0,08 m<sup>3</sup>



490 x 325 x 525 mm



2,91 kg



480 x 315 x 525 mm





# CH6



x1



x3



x4



x1

CH6



0,07 m<sup>3</sup>



490 x 325 x 485 mm



2,61 kg



480 x 315 x 485 mm

# CH8



x1



x3



x5



x1



CH8



0,1 m<sup>3</sup>



590 x 410 x 655 mm



3,28 kg



480 x 315 x 645 mm

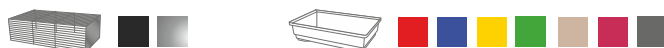



# BENEK



BENEK



5 906775 663042



x1



x2



x4



x1

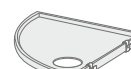

x1



0,07 m<sup>3</sup>



540 x 380 x 645 mm



3,41 kg



480 x 315 x 615 mm

# KASKADA



KASKADA



5 906775 661239



x1

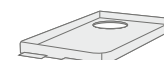

x3



x5



x1



0,07 m<sup>3</sup>



560 x 380 x 620 mm



3,22 kg



480 x 315 x 600 mm





# STANDARD D



STANDARD D



x1

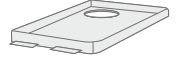

x1



x3



x1

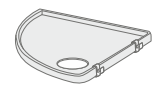

x1



0,07 m<sup>3</sup>



490 x 325 x 415 mm



3,33 kg



480 x 315 x 415 mm

# STANDARD W



STANDARD W



x1



x1

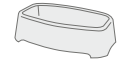

x1

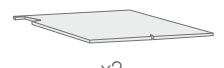

x2

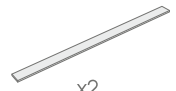

x2



0,07 m<sup>3</sup>



490 x 325 x 415 mm



2,70 kg



480 x 315 x 415 mm



# BEN



BEN



5 906775 661475



x1



x6



x1

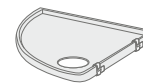

x3



0,09 m<sup>3</sup>



700 x 430 x 700 mm



4,64 kg



590 x 360 x 670 mm

# BOB



BOB



5 906775 660478



x1



x2



x1



x2



0,035 m<sup>3</sup>



675 x 350 x 250 mm



2,20 kg



665 x 340 x 250 mm





# ED



x1



x6



x1

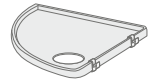

x3

ED



0,09 m<sup>3</sup>



600 x 370 x 640 mm



4,45 kg



590 x 360 x 640 mm

# KEN



x1



x4



x1

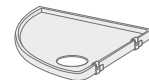

x2

KEN

KEN OCYNK



0,06 m<sup>3</sup>



600 x 370 x 360 mm



3,02 kg



590 x 360 x 360 mm

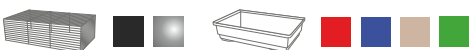



# KEN W



x1



x1

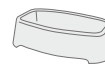

x1



x2

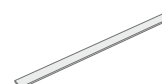

x2

KEN W



5 906775 660522

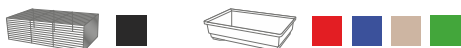

0,06 m<sup>3</sup>



600 x 370 x 360 mm



3,20 kg



590 x 360 x 360 mm

# TRAPEZ



x1

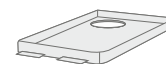

x2



x4



x1

TRAPEZ



5 906775 661895



0,09 m<sup>3</sup>



600 x 370 x 400 mm



3,02 kg



590 x 360 x 400 mm



# MIKUŚ

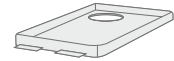

x1



x1

MIKUŚ

MIKUŚ OCYNK



0,06 m<sup>3</sup>



335 x 200 x 195 mm



1,00 kg



325 x 190 x 195 mm

# DIXI



x1



x2



x1

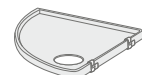

x1

DIXI



0,035 m<sup>3</sup>



490 x 325 x 290 mm



2,17 kg



480 x 315 x 290 mm



# PIXI



PIXI

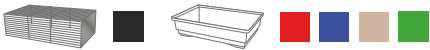

x1



x3

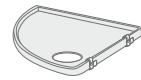

x1



0,07 m<sup>3</sup>



600 x 370 x 420 mm



2,85 kg



590 x 360 x 420 mm



# REMI



REMI

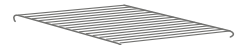
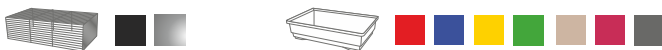

x3

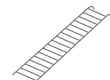

x3



x1



0,09 m<sup>3</sup>



490 x 325 x 690 mm



3,05 kg



480 x 315 x 690 mm

# TOM I



TOM I

TOM I OCYNK



x1

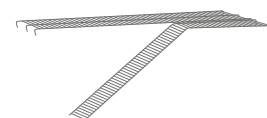

x2



0,09 m<sup>3</sup>



600 x 370 x 640 mm



5,02 kg



590 x 360 x 640 mm

# FRETKA80 OCYNK



FRETKA80 OCYNK

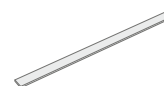
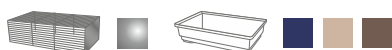

x2

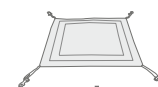

x1



x2



0,16 m<sup>3</sup>



800 x 440 x 800 mm



6,30 kg



790 x 430 x 800 mm



# SZYNSZYLA 60



SZYNSZYLA 60



SZYNSZYLA 60 OC



0,12 m<sup>3</sup>



600 x 370 x 855 mm



4,52 kg



590 x 360 x 855 mm

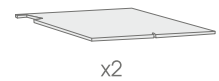

# SZYNSZYLA 80 OCYNK



SZYNSZYLA 80 OCYNK



0,16 m<sup>3</sup>



800 x 440 x 800 mm



5,80 kg



790 x 430 x 800 mm

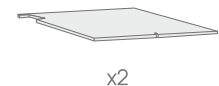



# SM



SM

SMOC



0,11 m<sup>3</sup>



490 x 325 x 330 mm



1,45 kg



480 x 315 x 330 mm

# K50



K50



stretch



0,037 m<sup>3</sup>



490 x 325 x 315 mm



1,35 kg



480 x 315 x 315 mm





# K60

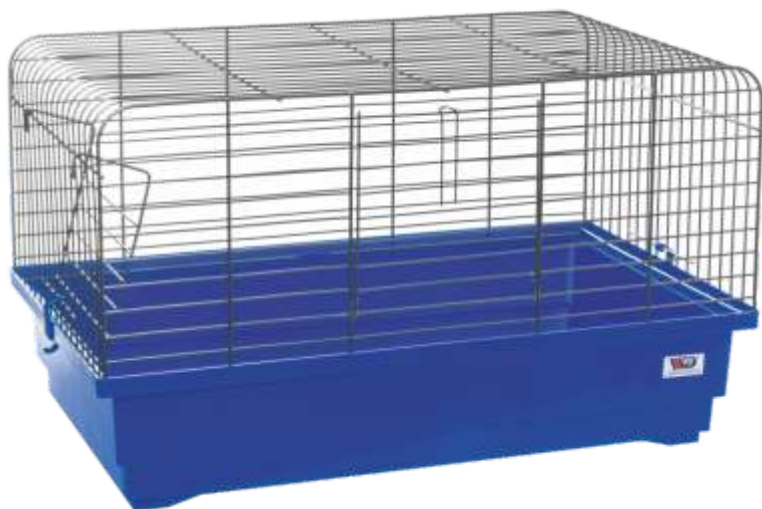

K60

K60 OCYNK



0,06 m<sup>3</sup>



600 x 370 x 355 mm



2,45 kg



585 x 360 x 355 mm

# K60 N

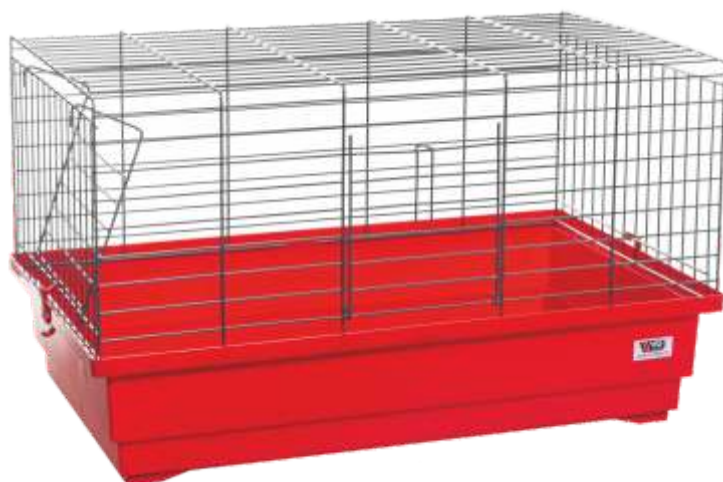

K60 N

K60 N OCYNK



0,05 m<sup>3</sup>



600 x 370 x 275 mm



2,05 kg



590 x 360 x 275 mm







# K60 S



K60

K60 OCYNK



0,03 m<sup>3</sup>



600 x 370 x 370 mm



2,20 kg



590 x 360 x 370 mm

# K70

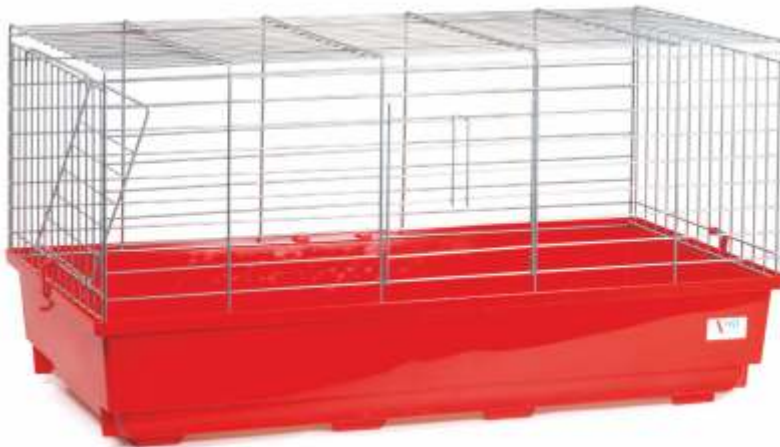

K70

STRETCH



0,06 m<sup>3</sup>



680 x 350 x 355 mm



1,95 kg



670 x 350 x 355 mm





# K80 FIL



K80 FIL

K80 FIL OCYNK



0,15 m<sup>3</sup>



800 x 440 x 390 mm



3,15 kg



790 x 430 x 390 mm



# K80 N



K80 N

K80 N OCYNK



0,08 m<sup>3</sup>



800 x 440 x 340 mm



3,00 kg



790 x 430 x 340 mm





# K80 S



K80 S

K80 S OCYNK



0,08 m<sup>3</sup>



800 x 440 x 410 mm



3,68 kg



790 x 430 x 410 mm

# K100 N OCYNK

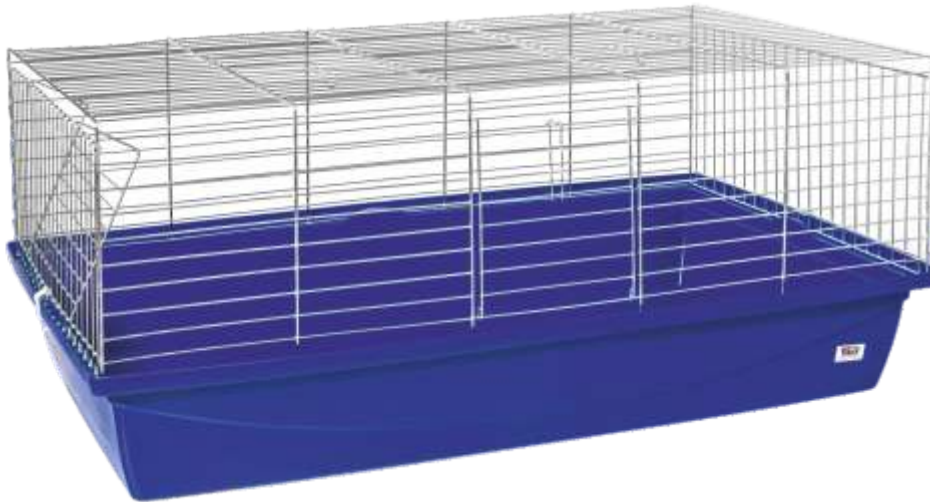

K100 N OCYNK



0,18 m<sup>3</sup>



985 x 530 x 440 mm



4,85 kg



970 x 515 x 440 mm

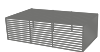



# K100 S

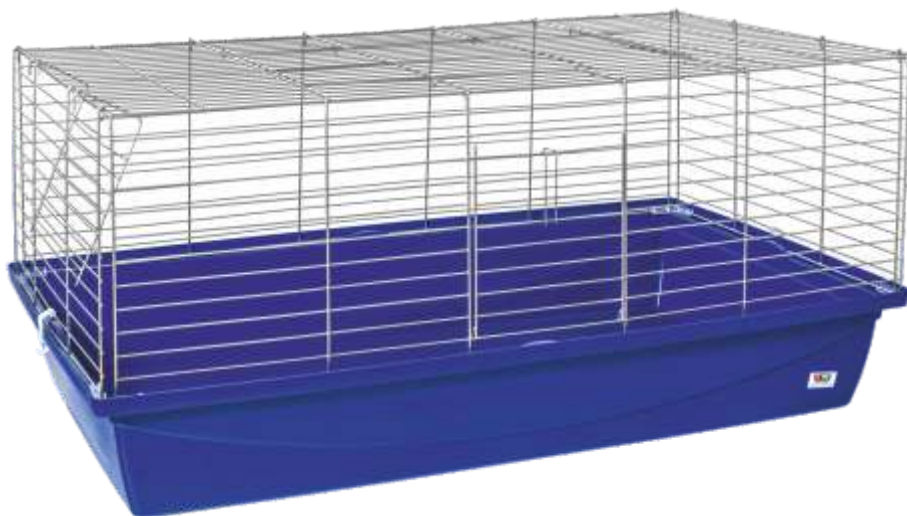

K100 S

K100 S OCYNK



0,13 m<sup>3</sup>



985 x 530 x 455 mm



5,53 kg



970 x 515 x 455 mm

# K120 S OCYNK

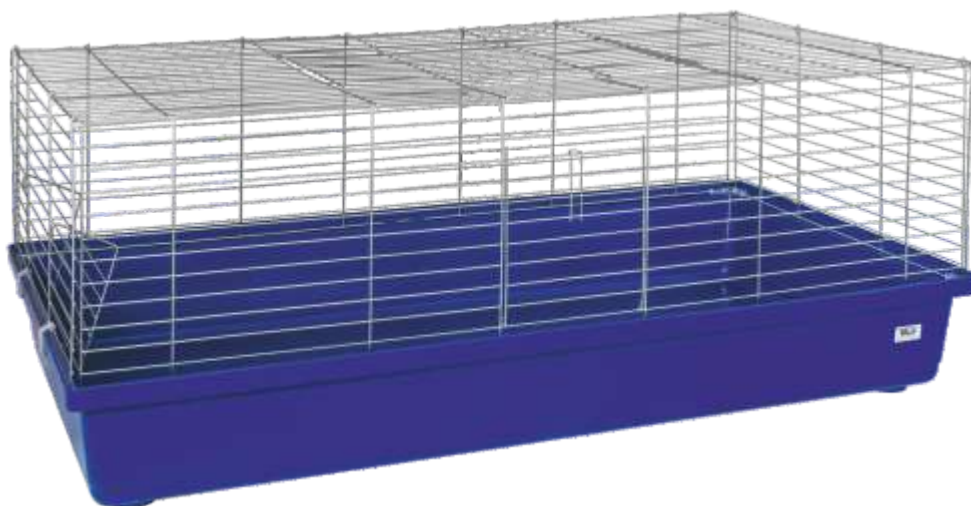

K120 S OCYNK



0,26 m<sup>3</sup>



1200 x 590 x 480 mm



5,90 kg



1180 x 570 x 480 mm



# PL M



PL M

PL M OCYNK



0,05 m<sup>3</sup>



1,18 kg



980 x 405 mm

# PL D



PL D

PL D OCYNK



0,07 m<sup>3</sup>



1,72 kg



980 x 600 mm



# AKCESORIA DLA MAŁYCH ZWIERZĄT ACCESSORIES FOR SMALL ANIMALS

---



A



B



C



J



D



E



F





KULA DLA CHOMIKA / HAMSTER BALL



KULA NA STOJAKU / HAMSTER BALL WITH STAND



H



I



SGM 335x200



SGS 400x255



SGD 490x325



SG60 600x370

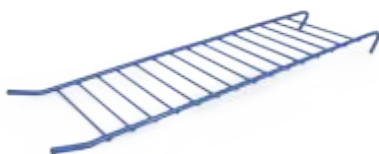

L



K



G









# KLATKI DLA PTAKÓW

CAGES FOR BIRDS



# 001



2

001

001 OCYNK



0,045 m<sup>3</sup>



410 x 200 x 320 mm



1,02 kg



325 x 190 x 310 mm

# 002



2

002

002 OCYNK



0,045 m<sup>3</sup>



380 x 200 x 320 mm



1,02 kg



325 x 190 x 310 mm



KM



KM

KM OCYNK



0,034 m<sup>3</sup>



335 x 200 x 285 mm



1,01 kg



325 x 190 x 285 mm

# Klatka JEŻYK M



Klatka JEŻYK M

Klatka JEŻYK M OC



0,06 m<sup>3</sup>



400 x 200 x 380 mm



1,26 kg



325 x 190 x 350 mm





# 003



003

003 OCYNK



0,098 m<sup>3</sup>



500 x 255 x 420 mm



1,62 kg



390 x 245 x 390 mm

# 004



004

004 OCYNK



0,098 m<sup>3</sup>



473 x 255 x 395 mm



1,61 kg



390 x 245 x 395 mm



# DO M



DO M

DO M OCYNK



0,07 m<sup>3</sup>



475 x 308 x 475 mm



1,73 kg



390 x 245 x 400 mm



# DO D



DO D

DO D OCYNK



0,076 m<sup>3</sup>



470 x 308 x 605 mm



2,05 kg



390 x 245 x 500 mm





# KS1



KS1

KS1 OCYNK



0,076 m<sup>3</sup>



490 x 320 x 575 mm



2,05 kg



390 x 245 x 490 mm



2

# KS2



KS2

KS2 OCYNK



0,07 m<sup>3</sup>



492 x 325 x 385 mm



1,66 kg



390 x 245 x 335 mm



2



# KS3



KS3

KS3 OCYNK



0,076 m<sup>3</sup>



505 x 325 x 575 mm



2,10 kg



390 x 245 x 480 mm



# KS4



KS4

KS4 OCYNK



0,076 m<sup>3</sup>



510 x 325 x 580 mm



2,08 kg



390 x 245 x 500 mm





# KS5



KS5

KS5 OCYNK



0,076 m<sup>3</sup>



585 x 375 x 515 mm



2,20 kg



390 x 245 x 450 mm



2

# KS6



KS6

KS6 OCYNK



0,076 m<sup>3</sup>



510 x 325 x 585 mm



1,98 kg



390 x 245 x 500 mm



2





# KS7



KS7

KS7 OCYNK



0,06 m<sup>3</sup>



400 x 255 x 345 mm



1,61 kg



390 x 245 x 345 mm

# KS8



KS8

KS8 OCYNK



0,08 m<sup>3</sup>



400 x 255 x 475 mm



1,74 kg



390 x 245 x 475 mm





# KS9



KS9



0,035 m<sup>3</sup>



400 x 255 x 385 mm



1,55 kg



390 x 245 x 385 mm

# Klatka JEŹYK S



Klatka JEŹYK S

Klatka JEŹYK S OCYNK



0,1 m<sup>3</sup>



480 x 255 x 470 mm



1,73 kg



390 x 245 x 430 mm



# MAJA



MAJA



0,06 m<sup>3</sup>



400 x 255 x 540 mm



1,75 kg



390 x 245 x 500 mm

# DW D



DW D

DW D OCYNK



0,1 m<sup>3</sup>



555 x 385 x 645 mm



2,94 kg



444 x 325 x 540 mm

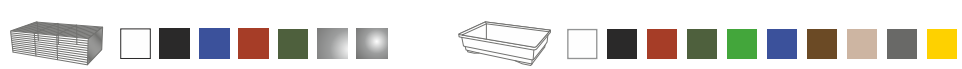



# K1



K1

K1 OCYNK



0,1 m<sup>3</sup>



545 x 400 x 630 mm



2,79 kg



444 x 325 x 530 mm



2

# K2



K2

K2 OCYNK



0,1 m<sup>3</sup>



454 x 335 x 595 mm



2,60 kg



444 x 325 x 595 mm



2



# K3



2

K3

K3 OCYNK



0,1 m<sup>3</sup>



570 x 400 x 625 mm



2,90 kg



444 x 325 x 525 mm

# K4



2

K4

K4 OCYNK



0,086 m<sup>3</sup>



600 x 334 x 505 mm



2,70 kg



444 x 325 x 505 mm





# K5



K5



0,1 m<sup>3</sup>



600 x 365 x 590 mm



2,92 kg



444 x 325 x 500 mm

# K6



K6

K6 OCYNK



0,09 m<sup>3</sup>



575 x 335 x 550 mm



2,72 kg



444 x 325 x 550 mm

# K7



K7

K7 OCYNK



2



0,1 m<sup>3</sup>



590 x 400 x 640 mm



3,00 kg



444 x 325 x 500 mm

# K8



K8

K8 OCYNK



2



0,1 m<sup>3</sup>



560 x 400 x 640 mm



2,83 kg



444 x 325 x 500 mm





# K9



K9

K9 OCYNK



0,08 m<sup>3</sup>



454 x 335 x 590 mm



2,60 kg



444 x 325 x 590 mm

# K10



K10

K10 OC



0,11 m<sup>3</sup>



595 x 335 x 585 mm



2,74 kg



444 x 325 x 585 mm





# Klatka ASIA



Klatka ASIA



Klatka ASIA OC



2



0,08 m<sup>3</sup>



550 x 400 x 590 mm



2,75 kg



444 x 325 x 550 mm



# Klatka BETI



Klatka BETI



2



0,08 m<sup>3</sup>



455 x 335 x 600 mm



2,70 kg



445 x 323 x 600 mm





# Klatka ELA



Klatka ELA

Klatka ELA OC



0,13 m<sup>3</sup>



505 x 385 x 635 mm



2,90 kg



444 x 325 x 535 mm



2

# Klatka KASIA



Klatka KASIA

Klatka KASIA OC



0,1 m<sup>3</sup>



530 x 390 x 560 mm



2,68 kg



444 x 325 x 500 mm



2



# Klatka POLA

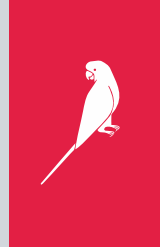

Klatka POLA

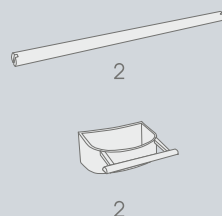

0,08 m<sup>3</sup>



455 x 335 x 600 mm



2,70 kg



445 x 323 x 600 mm



# Klatka ULA



Klatka ULA



Klatka ULA OC



0,06 m<sup>3</sup>



560 x 400 x 535 mm



2,73 kg



444 x 325 x 525 mm

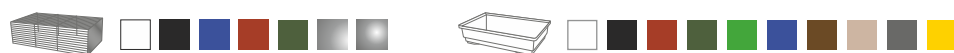



# Klatka AGA



4

Klatka AGA

Klatka AGA OC



5 906775 662021

5 906775 662359



0,09 m<sup>3</sup>



700 x 420 x 690 mm



4,73 kg



590 x 360 x 650 mm

# Klatka AMADYNA



4

Klatka AMADYNA

Klatka AMADYNA OC



5 906775 661727

5 906775 662366



0,15 m<sup>3</sup>



740 x 425 x 900 mm



5,14 kg



590 x 360 x 850 mm



# Klatka ASIA 60

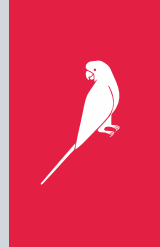

Klatka ASIA 60

Klatka ASIA 60 OC



4



0,1 m<sup>3</sup>



700 x 420 x 725 mm



4,16 kg



590 x 360 x 680 mm

# Klatka COCO



Klatka COCO



4



0,09 m<sup>3</sup>



600 x 370 x 500 mm

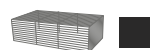

4,10 kg



590 x 360 x 500 mm



# Klatka NIMFA 60



Klatka NIMFA 60

Klatka NIMFA 60 OC



0,12 m<sup>3</sup>



600 x 370 x 850 mm



4,70 kg



590 x 360 x 850 mm



4

# Klatka ROZELA 60



Klatka ROZELA 60

Klatka ROZELA 60 OC



0,12 m<sup>3</sup>



600 x 370 x 855 mm



4,88 kg



590 x 360 x 855 mm



# Klatka SARA 60 D



Klatka SARA 60 D

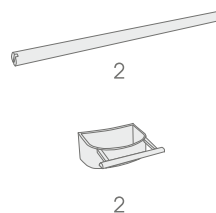

0,14 m<sup>3</sup>
 600 x 370 x 650/880 mm  
 3,8 kg
 590 x 360 x 650 mm

# Klatka ULA 60



Klatka ULA 60



Klatka ULA 60 OC



0,09 m<sup>3</sup>
 700 x 425 x 690 mm  
 4,05 kg
 590 x 360 x 690 mm



# Klatka na stojaku JOLA D



Klatka na stojaku JOLA D

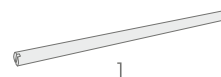

1



3



4



0,13 m<sup>3</sup>



565 x 370 x 1330 mm



4,30 kg



560 x 360 x 660 mm

# Klatka na stojaku ULA



Klatka na stojaku ULA



3



4



0,16 m<sup>3</sup>



630 x 420 x 1340 mm



4,40 kg



560 x 360 x 600 mm





# Klatka NIMFA 80 OC



Klatka NIMFA 80 OC



4



0,16 m<sup>3</sup>



800 x 440 x 800 mm



5,60 kg



790 x 430 x 800 mm

# Klatka ROZELA 80 OC



Klatka ROZELA 80 OC



0,16 m<sup>3</sup>



800 x 440 x 800 mm



5,80 kg



790 x 430 x 800 mm





# STOJAK S 1

---

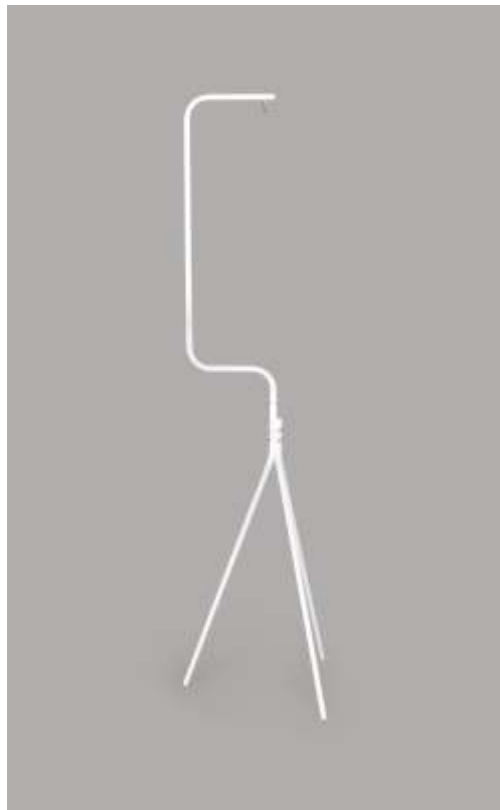

STOJAK S1



H: 1640 mm

# STOJAK S2

---

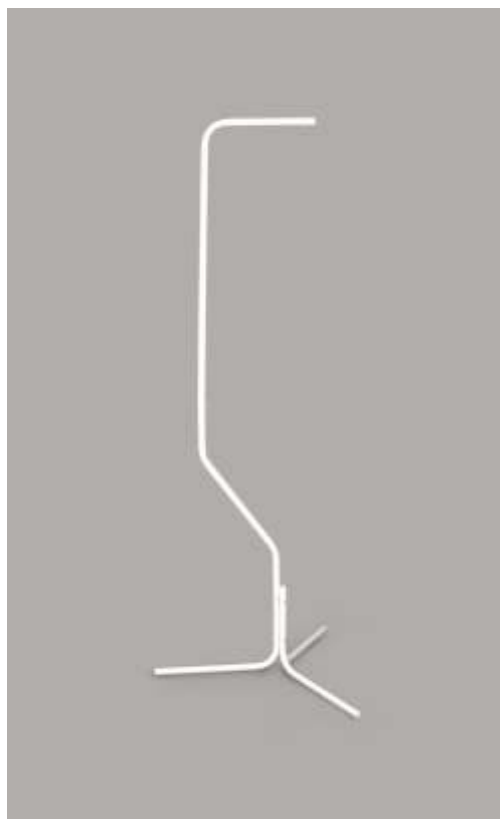

STOJAK S2



H: 1630 mm

# AKCESORIA DLA PTAKÓW ACCESSORIES FOR BIRDS

---



Aa



Ba



Da



Ca



SPM 335x200



SPS 400x255



SPD 455x335



SP60 600x370



Ea



INSTRUKCJA  
INSTRUCTION

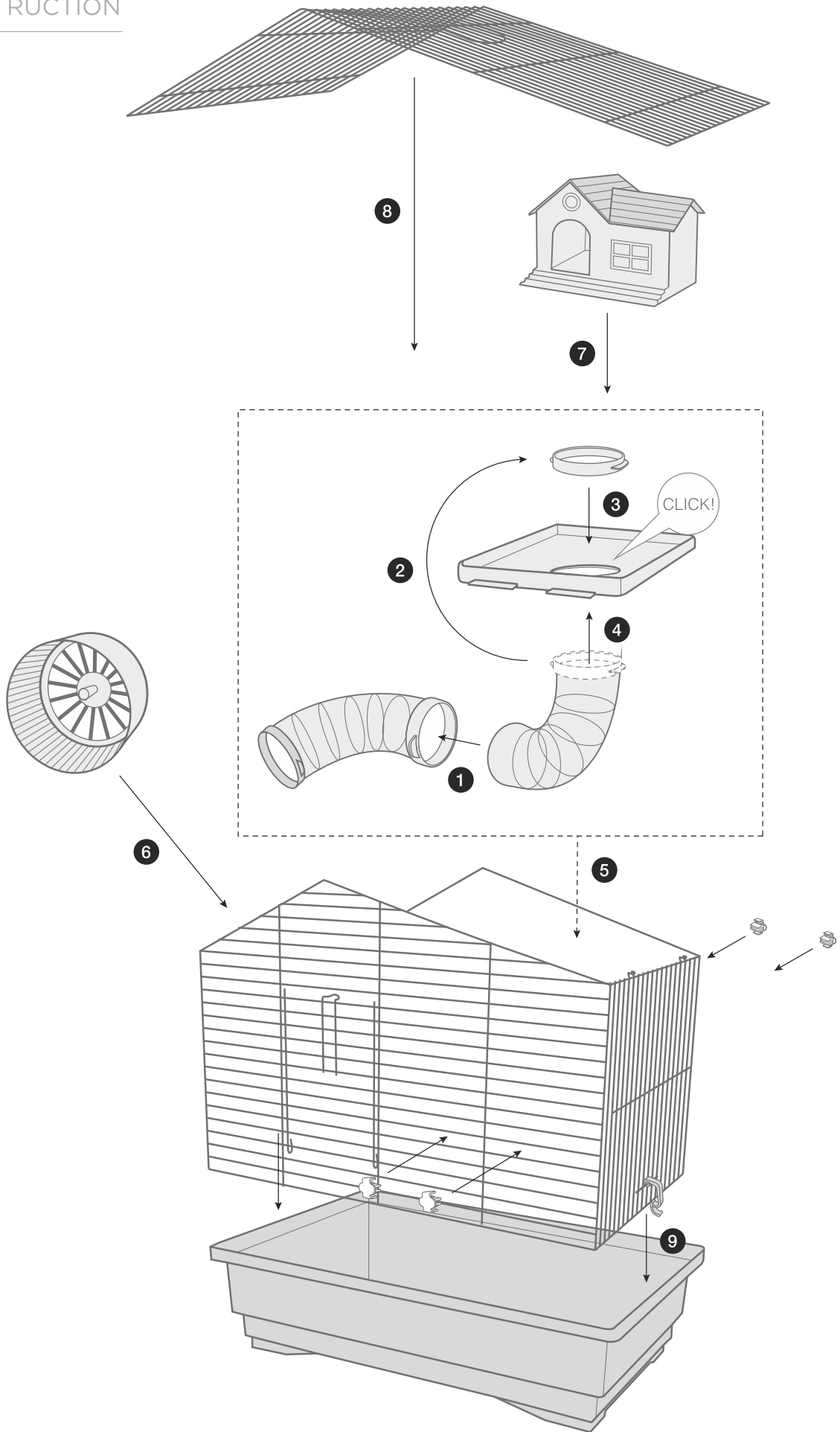

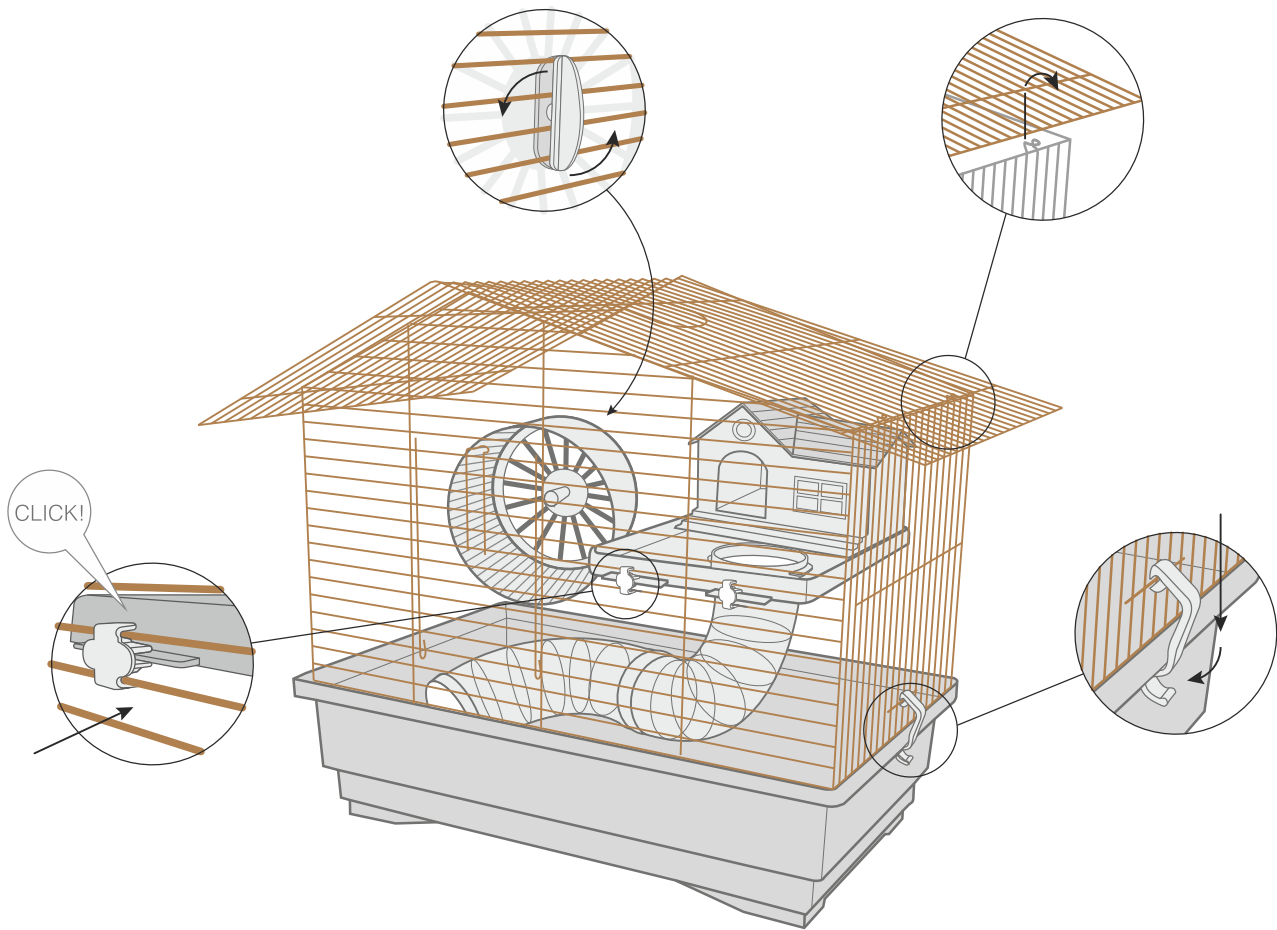

BG – в зависимост от модела  
 CZ – v závislosti na modelu  
 DE – je nach Modell  
 DK – afhængigt af model  
 GR – ανάλογα με το μοντέλο  
 EN – depending on model

ES – dependiendo del modelo  
 EE – olenevalt mudeli st  
 FI – mallista riippuen  
 FR – selon le modèle  
 HU – modelltől függően  
 HR – ovisno o modelu

IT – a seconda del modello  
 LT – pri klausomai nuo modeli o  
 LV – atkarībā no modeļa  
 NL – afhankelijk van het model  
 NO – avhengig av model  
 PL – w zależności od modelu

PT – dependendo do modelo  
 RO – în funcție de model  
 RU – в зависимости от модели  
 SE – beroende på modell  
 SK – v závislosti na modeli  
 UA – в залежності від моделі

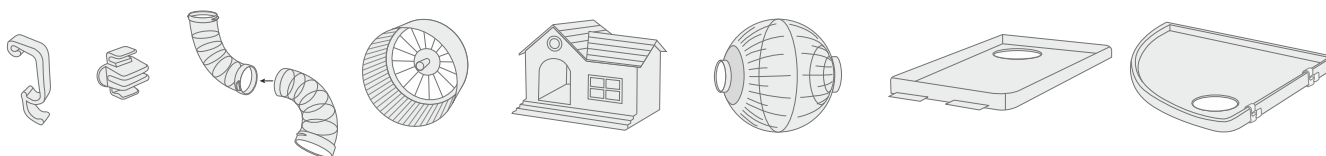
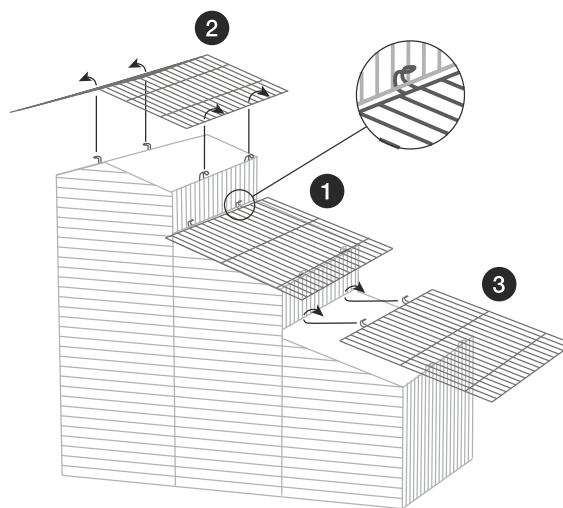
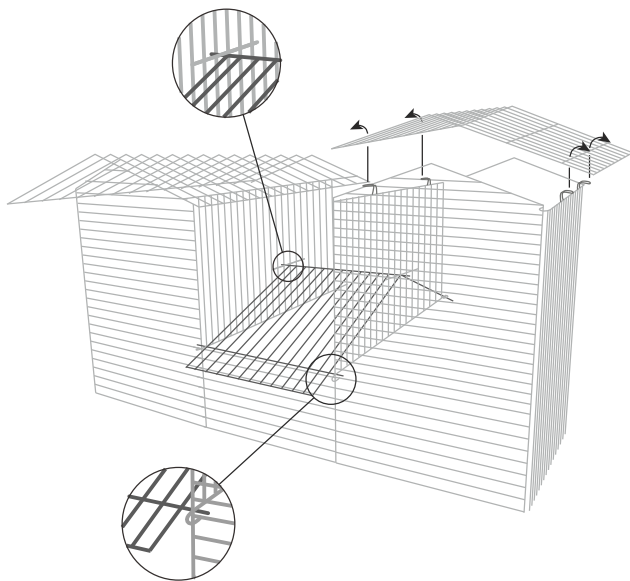





WD-IMPEX Mikołajewski, Jakubow, Spółka Jawna  
ul. Meliorantów 67c, 42-200 Częstochowa  
tel. +48 34 362 77 30, fax +48 34 362 78 21  
NIP: 573-000-44-73  
KRS: 0000079202  
biuro@wd-impex.com.pl

[www.wd-impex.com.pl](http://www.wd-impex.com.pl)

